



**COURSE OVERVIEW PE0221**

**Operation of Process Equipment**

*Fired Heaters, Air Coolers, Heat Exchangers, Pumps, Compressors, Crude Desalter, Pressure Vessels & Valves*

**Course Title**

Operation of Process Equipment: *Fired Heaters, Air Coolers, Heat Exchangers, Pumps, Compressors, Crude Desalter, Pressure Vessels & Valves*

**Course Reference**

PE0221

**Course Duration/Credits**

Five days/3.0 CEUs/30 PDHs

**Course Date/Venue**

Session(s)	Dates	Venue
1	May 05-09, 2024	The Kooh Al Noor Meeting Room, The H Dubai Hotel, Sheikh Zayed Rd - Trade Centre, Dubai, UAE
2	August 11-15, 2024	Kizkulesi, Crown Plaza Istanbul Asia Hotels & Convention Center, Istanbul, Turkey
3	December 08-12, 2024	Oryx Meeting Room, Doubletree By Hilton Doha-Al Sadd, Doha, Qatar
4	January 20-24, 2025	Hampstead Meeting Room, London Marriott Hotel Regents Park, London, United Kingdom



**Course Description**



***This practical and highly-interactive course includes various practical sessions and exercises. Theory learnt will be applied using our state-of-the-art simulators.***

The course is designed to provide delegates with a detailed and up-to-date overview on the operation of the hydrocarbon process equipment that includes fired heaters, air coolers, heat exchangers, pumps, compressors, crude desalter, pressure vessels and valves.

It covers the characteristics of crude oil and function of chemicals used in the process such as composition of petroleum, hydrocarbon properties, salt concentration and emulsions.

At the completion of the course, participants will be able to apply oil treating; dehydration and desalting; process and equipment operations; and employ the sequence of desalter plant start-up.

The course will also cover the different types and function of direct fired heaters; safety aspects; air coolers; heat exchangers; pumps; compressors; process vessels; valves; and troubleshooting of different equipment and processes.



## Course Objectives

Upon the successful completion of this course, each participant will be able to:-

- Apply proper techniques and procedures on the operation of the hydrocarbon process equipment such as fired heaters, air coolers, heat exchangers, pumps, compressors, crude desalter, pressure vessels and valves
- Enumerate the characteristics of crude oil and identify the function of chemicals used in the process such as composition of petroleum, hydrocarbon properties, salt concentration and emulsions
- Discuss oil treating, dehydration and desalting including the process and equipment operations
- Employ the sequence of desalter plant start-up and identify the different types and function of direct fired heaters including the safety aspects
- Differentiate the various types of air coolers, heat exchangers, pumps and compressors
- Describe the types and functions of process vessels and valves including the troubleshooting of different equipments and processes

## Exclusive Smart Training Kit - H-STK®



Participants of this course will receive the exclusive “Haward Smart Training Kit” (H-STK®). The H-STK® consists of a comprehensive set of technical content which includes **electronic version** of the course materials, sample video clips of the instructor’s actual lectures & practical sessions during the course conveniently saved in a **Tablet PC**.

## Who Should Attend

This course provides an overview of all operational aspects of the hydrocarbon process equipment for engineers and other technical staff who are involved in the operation and troubleshooting of various process equipment including fired heaters, air coolers, heat exchangers, pumps, compressors, crude desalter, pressure vessels and valves. The course is also beneficial for design engineers and maintenance staff.

## Training Methodology

All our Courses are including **Hands-on Practical Sessions** using equipment, State-of-the-Art Simulators, Drawings, Case Studies, Videos and Exercises. The courses include the following training methodologies as a percentage of the total tuition hours:-

- 30% Lectures
- 20% Practical Workshops & Work Presentations
- 30% Hands-on Practical Exercises & Case Studies
- 20% Simulators (Hardware & Software) & Videos

In an unlikely event, the course instructor may modify the above training methodology before or during the course for technical reasons.



**Course Certificate(s)**

Internationally recognized certificates will be issued to all participants of the course who completed a minimum of 80% of the total tuition hours.

**Certificate Accreditations**

Certificates are accredited by the following international accreditation organizations:-

- 
The International Accreditors for Continuing Education and Training (IACET - USA)

Haward Technology is an Authorized Training Provider by the International Accreditors for Continuing Education and Training (IACET), 2201 Cooperative Way, Suite 600, Herndon, VA 20171, USA. In obtaining this authority, Haward Technology has demonstrated that it complies with the **ANSI/IACET 2018-1 Standard** which is widely recognized as the standard of good practice internationally. As a result of our Authorized Provider membership status, Haward Technology is authorized to offer IACET CEUs for its programs that qualify under the **ANSI/IACET 2018-1 Standard**.

Haward Technology’s courses meet the professional certification and continuing education requirements for participants seeking **Continuing Education Units (CEUs)** in accordance with the rules & regulations of the International Accreditors for Continuing Education & Training (IACET). IACET is an international authority that evaluates programs according to strict, research-based criteria and guidelines. The CEU is an internationally accepted uniform unit of measurement in qualified courses of continuing education.

Haward Technology Middle East will award **3.0 CEUs** (Continuing Education Units) or **30 PDHs** (Professional Development Hours) for participants who completed the total tuition hours of this program. One CEU is equivalent to ten Professional Development Hours (PDHs) or ten contact hours of the participation in and completion of Haward Technology programs. A permanent record of a participant’s involvement and awarding of CEU will be maintained by Haward Technology. Haward Technology will provide a copy of the participant’s CEU and PDH Transcript of Records upon request.

- 
British Accreditation Council (BAC)

Haward Technology is accredited by the **British Accreditation Council** for **Independent Further and Higher Education** as an **International Centre**. BAC is the British accrediting body responsible for setting standards within independent further and higher education sector in the UK and overseas. As a BAC-accredited international centre, Haward Technology meets all of the international higher education criteria and standards set by BAC.

**Accommodation**

Accommodation is not included in the course fees. However, any accommodation required can be arranged at the time of booking.



### Course Instructor(s)

This course will be conducted by the following instructor(s). However, we have the right to change the course instructor(s) prior to the course date and inform participants accordingly:



**Mr. Karl Thanasis**, PEng, MSc, MBA, BSc, is a **Senior Engineer** with over **30 years** of practical experience within the **Oil, Gas, Refinery** and **Petrochemical** industries. His wide expertise includes **Process Plant Optimization Technology & Continuous Improvement, Process Engineering Calculations, Process Plant Start Up & Commissioning, Applied Process Engineering Elements, Coke Cooler, Process Plant Start-up & Commissioning, Process Plant Troubleshooting, Operations Abnormalities & Plant Upset, Process Equipment Applications & Troubleshooting, Process Plant Performance & Efficiency, Gas Sweetening & Sulphur Recovery, Distillation-Column Control & Troubleshooting, Oil Movement & Troubleshooting, Process Plant Operations & Control, Process Equipment Operation, Fired Heaters & Air Coolers Maintenance, Heat Exchangers, Pumps & Compressors, Crude Desalter, Pressure Vessels & Valves, Steam Trapping & Control, Pumps & Valve Maintenance & Troubleshooting, Turbomachinery, Mechanical Alignment, Rotating Equipments, Diesel Generators, Lubrication Technology, Bearing, Predictive & Preventive Maintenance, Root Cause Analysis, Boilers, Oil Field Operation, Production Operation, Plant Operation & Commissioning, Crude Oil De Salting Process, Gas Conditioning, NGL Recovery & NGL Fractionation, Flare System, Storage Tanks, Oil Recovery System and Chemical Injection.**

Mr. Thanasis has acquired his thorough and practical experience as the **Project Manager, Plant Manager, Area Manager - Equipment Construction, Construction Superintendent, Project Engineer and Design Engineer**. His duties covered **Plant Preliminary Design, Plant Operation, Write-up of Capital Proposal, Investment Approval, Bid Evaluation, Technical Contract Write-up, Construction and Sub-contractor Follow up, Lab Analysis, Sludge Drying and Management of Sludge Odor and Removal**. He has worked in various companies worldwide in the **USA, Germany, England and Greece**.

Mr. Thanasis is a **Registered Professional Engineer** in the **USA and Greece** and has a **Master and Bachelor** degrees in **Mechanical Engineering with Honours** from the **Purdue University and SIU in USA** respectively as well as an **MBA** from the **University of Phoenix in USA**. Further, he is a **Certified Internal Verifier/Trainer/Assessor** by the **Institute of Leadership & Management (ILM)** and a **Certified Instructor/Trainer**.



**Course Fee**

Dubai	<b>US\$ 5,500</b> per Delegate + <b>VAT</b> . This rate includes H-STK® (Haward Smart Training Kit), buffet lunch, coffee/tea on arrival, morning & afternoon of each day.
Istanbul	<b>US\$ 6,000</b> per Delegate + <b>VAT</b> . This rate includes Participants Pack (Folder, Manual, Hand-outs, etc.), buffet lunch, coffee/tea on arrival, morning & afternoon of each day.
Doha	<b>US\$ 6,000</b> per Delegate. This rate includes H-STK® (Haward Smart Training Kit), buffet lunch, coffee/tea on arrival, morning & afternoon of each day.
London	<b>US\$ 8,800</b> per Delegate + <b>VAT</b> . This rate includes Participants Pack (Folder, Manual, Hand-outs, etc.), buffet lunch, coffee/tea on arrival, morning & afternoon of each day.

In addition to the Course Manual, participants will receive an e-book “Operator’s Guide to Rotating Equipment: An Introduction to Rotating Equipment Construction, Operating Principles, Troubleshooting and Best Practices”, published by AuthorHouse.

**Course Program**

The following program is planned for this course. However, the course instructor(s) may modify this program before or during the course for technical reasons with no prior notice to participants. Nevertheless, the course objectives will always be met:

**Day 1**

0730 – 0800	<i>Registration &amp; Coffee</i>
0800 – 0815	<i>Welcome &amp; Introduction</i>
0815 – 0830	<b>PRE-TEST</b>
0830 – 0930	<b>Characteristics of Crude Oil</b> <i>Composition of Petroleum • Hydrocarbon Gases Properties</i>
0930 – 0945	<i>Break</i>
0945 – 1100	<b>Characteristics of Crude Oil (cont’d)</b> <i>Salts Concentration • Emulsions • Function of Chemicals Used in the Process</i>
1100 – 1230	<b>Oil Treating, Dehydration &amp; Desalting</b> <i>Emulsion Formation &amp; Breaking • Vertical &amp; Horizontal Theater Operation • Electrostatic Theatre Design/Operation • The Desalting Process/Equipment • Emulsion Treating</i>
1230 – 1245	<i>Break</i>
1245 – 1420	<b>Oil Treating, Dehydration &amp; Desalting (cont’d)</b> <i>Separators – Free Water Knockout • Hetear Theatres – Other Treating Methods • Chemical – Electrical – Crude Oil Coolers (Heat Exchangers) • Control Valves Principles • Pumps Operation • Air Compressor Operation</i>
1420 – 1430	<b>Recap</b>
1430	<i>Lunch &amp; End of Day One</i>





**Day 2**

0730 – 0930	<b>Sequence of Desalter Plant Start-up</b>
0930 – 0945	Break
0945 – 1100	<b>Sequence of Desalter Plant Start-up (cont'd)</b>
1100 – 1230	<b>Direct-Fired Heaters</b> Design Considerations – Process & Combustion
1230 – 1245	Break
1245 – 1420	<b>Direct-Fired Heaters (cont'd)</b> Control System
1420 – 1430	<b>Recap</b>
1430	Lunch & End of Day Two

**Day 3**

0730 – 0930	<b>Air Coolers</b> Types – Forced and Induced Air • Key Operational Considerations
0930 – 0945	Break
0945 – 1100	<b>Air Coolers (cont'd)</b> Air vs Water Cooling • Troubleshooting
1100 – 1230	<b>Heat Exchangers</b> Types • Shell-and-Tube
1230 – 1245	Break
1245 – 1420	<b>Heat Exchangers (cont'd)</b> Heat Transfer Relation
1420 – 1430	<b>Recap</b>
1430	Lunch & End of Day Three

**Day 4**

0730 – 0930	<b>Pumps</b> Development of Static and Dynamic Head in the Operating Volume of Pumps for Efficiency and Control Operation • The Affinity Laws as Tools for Efficient Operation • Pump Auxiliaries
0930 – 0945	Break
0945 – 1100	<b>Pumps (cont'd)</b> Wear Components • Canned Motor and Magnetic Drive Pumps • High Speed/Low Flow Pumps • Servicing and Condition Monitoring
1100 – 1230	<b>Compressors</b> Types, Styles and Configurations of Centrifugal and Axial Compressors • Construction Features • Mode of Operation
1230 – 1245	Break
1245 – 1420	<b>Compressors (cont'd)</b> Compressor Auxiliaries and Support Systems • Analyse Operating Curves for Surge, Stall and Choke • Define Appropriate Equipment for Safe Operation
1420 – 1430	<b>Recap</b>
1430	Lunch & End of Day Four





Day 5

0730 – 0930	<b>Process Vessels</b> <i>Types and Functions • Safety Aspects</i>
0930 – 0945	<i>Break</i>
0945 – 1100	<b>Valves</b> <i>Valve Theory • Valve Types • Applications • Function • Operation • Troubleshooting</i>
1100 – 1230	<b>Troubleshooting of Different Equipment &amp; Processes</b>
1230 – 1245	<i>Break</i>
1245 – 1345	<b>Troubleshooting of Different Equipment &amp; Processes (cont'd)</b>
1345 – 1400	<b>Course Conclusion</b>
1400 – 1415	<b>POST-TEST</b>
1415 – 1430	<i>Presentation of Course Certificates</i>
1430	<i>Lunch &amp; End of Course</i>

**Simulator (Hands-on Practical Sessions)**

Practical sessions will be organized during the course for delegates to practice the theory learnt. Delegates will be provided with an opportunity to carryout various exercises using our state-of-the-art simulators “Heat Exchanger Tube Layout”, “Centrifugal Pumps and Troubleshooting Guide 3.0”, “SIM 3300 Centrifugal Compressor”, “CBT on Compressors”, “Valve Sizing Simulator”, “Valve Simulator 3.0”, “Valvestar 7.2 Simulator”, “PRV<sup>2</sup>SIZE Simulator”, and “ASPEN HYSYS” simulator.

**Heat Exchanger Tube Layout Simulator**

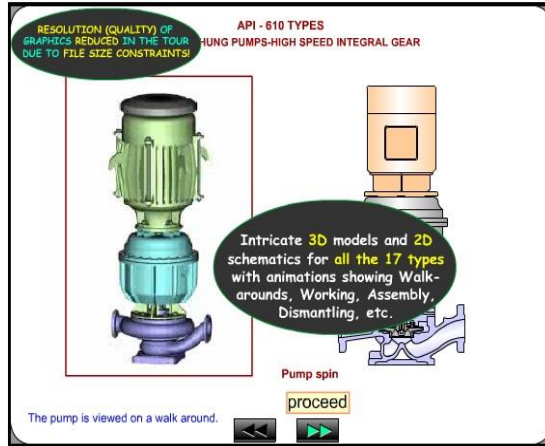

**Centrifugal Pumps and Troubleshooting Guide**

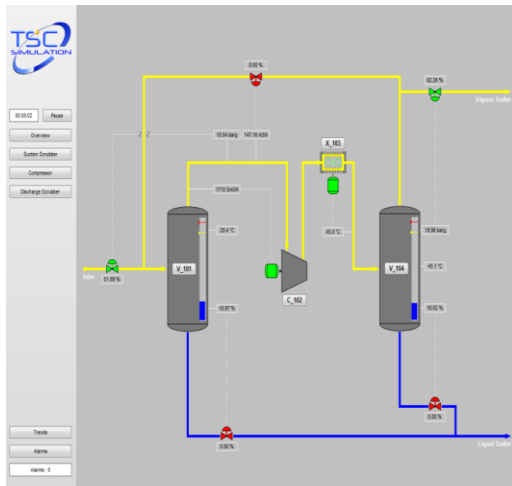

**SIM 3300 Centrifugal Compressor Simulator**

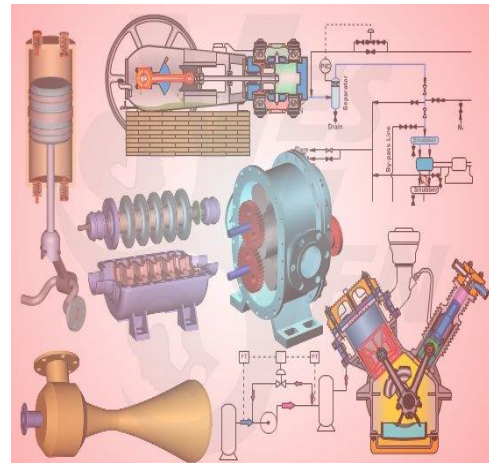

**CBT on Compressors**





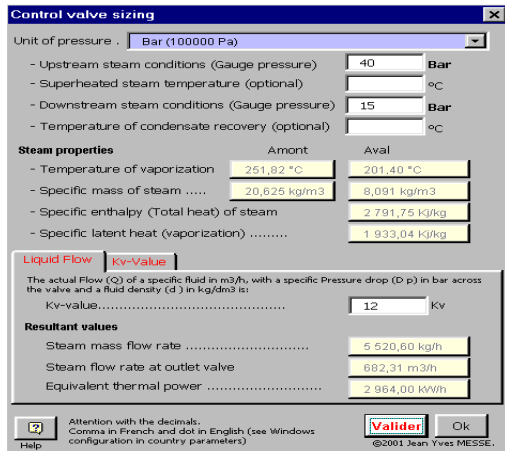

**Valve Sizing Simulator**

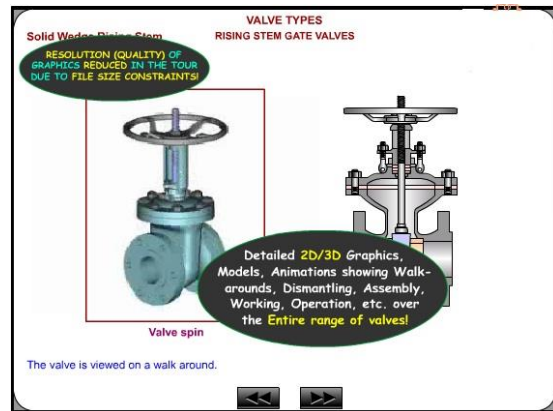

**Valve Simulator 3.0**

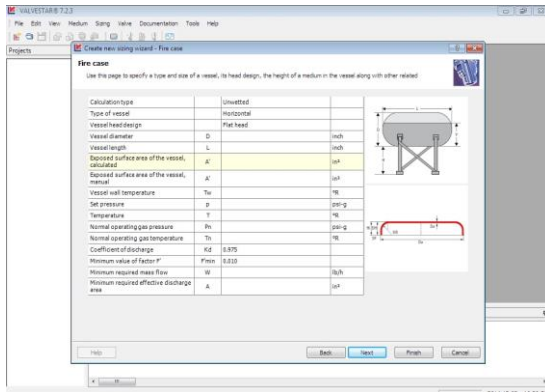

**Valvestar 7.2 Simulator**

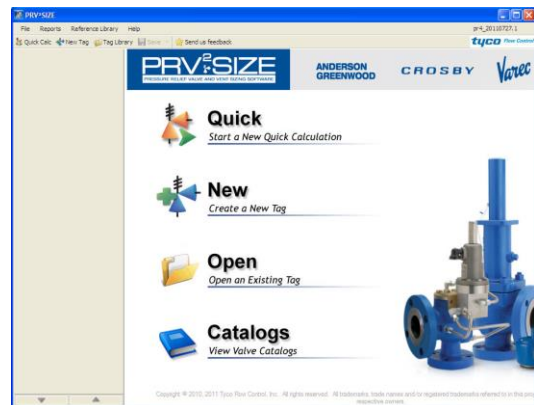

**PRV<sup>2</sup>SIZE Simulator**

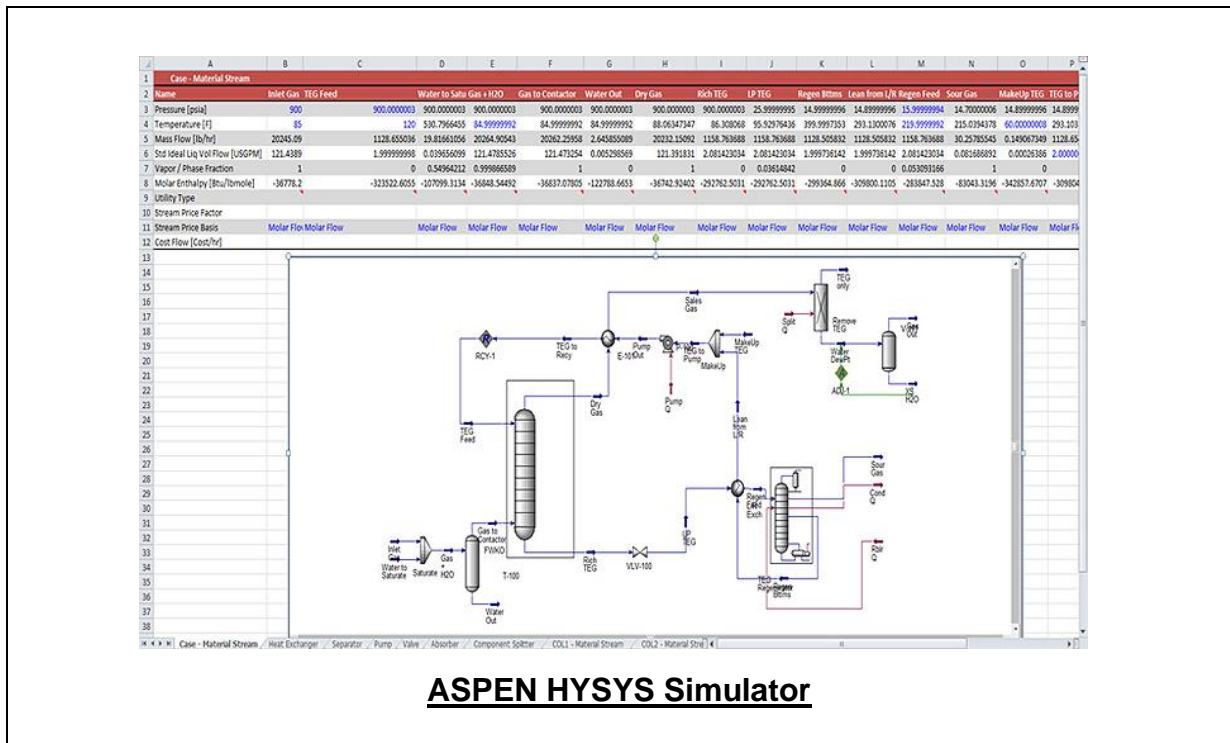

**ASPEN HYSYS Simulator**

**Book(s)**

As part of the course kit, the following e-book will be given to all participants:

**Title** : Operator's Guide to Rotating Equipment: An Introduction to Rotating Equipment Construction, Operating Principles, Troubleshooting and Best Practices

**ISBN** : 978-1-49690-868-1

**Authors** : Julien LeBleu  
Robert Perez

**Publisher** : AuthorHouse

**Course Coordinator**

Mari Nakintu, Tel: +971 2 30 91 714, Email: [mari@haward.org](mailto:mari@haward.org)