



## COURSE OVERVIEW EE0625 Advance Electrical Safety

### Course Title

Advanced Electrical Safety

### Course Date/Venue

Session 1: February 04-08, 2024/Oryx Meeting Room, Doubletree By Hilton Doha-Al Sadd, Doha, Qatar

Session 2: March 03-07, 2024/The Mouna Meeting Room, The H Dubai Hotel, Sheikh Zayed Rd - Trade Centre, Dubai, UAE

### Course Reference

EE0625

### Course Duration/Credits

Five days/3.0 CEUs/30 PDHs

### Course Description



***This practical and highly-interactive course includes various practical sessions and exercises. Theory learnt will be applied using our state-of-the-art simulators.***

High voltage electrical systems require the special application of maintenance, repair, test, and safety procedures. Personnel must be trained in special precautions to ensure both personnel and workplace safety. OSHA requires training for all qualified employees performing operations or maintenance work, or who have access to electrical power generation, transmission and distribution installations as well as HSE personnel who are in charge of the safety and health of the employees, public and facilities.



This course covers the knowledge and skills needed to safely work with energized high-voltage high-energy electric power systems. Principles and procedures for the safe operation and maintenance of high voltage systems are covered. Insulated hand tools, "hot-sticks", proper grounding procedures, proper protective clothing, and thorough job-planning procedures are stressed throughout the course. Properties of electric charge, energy, electric potential, dielectric stress, capacitive and inductive coupling, and material behavior in electromagnetic fields are covered. The effects of electrical energy on humans and various protection concepts are addressed, as are basic first aid practices. Differential protection schemes, insulation materials, Faraday cages, equi-potential grounding, live-line tools, and isolation techniques are covered from both the technical and practical perspectives.



Various OSHA, IEEE, IEC, European and NFPA safety procedures are reviewed. In this interactive course, group exercises include the development of safe-work protocols, use of lockout/tagout (LOTO), maintenance task rehearsal, and equipment preparation. Calculations of fault current, arc-flash hazards, and proper PPE selection are studied. Other technical topics covered include insulation testing (IR/PI/DAR/DD), four-wire Kelvin low-resistance testing, corona detection by ultrasonic and RF detectors, and signature analysis using an infrared imager.

Successful course participants who attend the course and pass competency exam, will be certified to work on high voltage electrical power systems. Course participants are introduced to the hazards of electrical work and the philosophies of preventing accident and minimizing outage time due to improper safety or work practices. Also included as part of the curriculum are study materials participants may use at their own pace to continue their learning experience. This course addresses OSHA training requirements established in OSHA 29 CFR 1910.269.

### **Course Objectives**

Upon the successful completion of this course, each participant will be able to:-

- Get certified on high voltage electrical safety in accordance with OSHA, NFPA, IEC, IEEE and EN standards
- Apply proper techniques and procedures on High Voltage (HV) electrical safety in accordance with the international standards OSHA, NFPA, IEEE and EN
- Explain the electrical safety standards and regulations including voltages
- Discuss basic electricity and HV installations
- Describe HV equipment including power transformers, switches, isolators and fuses, circuit breakers, instrument transformers, surge arrestors, capacitor banks as well as earth and shunt reactors
- Recognized the characteristics and applications of gas insulated substations (GIS) and review metal-enclosed and metal clad switchgears
- Analyze motor controllers, protection relays and carryout testing and commissioning
- Illustrate test equipment and discuss electrical switching as well as electrical and special hazards
- Apply hazardous area classification, classify hazardous materials, identify and control ignition sources, discuss HAC standards, identify and reduce/eliminate the risk and select electrical and equipment in hazardous areas
- Employ safety management and review de-energized and energized work

- Identify confined space as well as apply permit to work procedures and implementation
- Carryout personnel protection and emergency planning as well as identify portable cables

**Exclusive Smart Training Kit - H-STK®**



Participants of this course will receive the exclusive “Haward Smart Training Kit” (H-STK®). The H-STK® consists of a comprehensive set of technical content which includes **electronic version** of the course materials conveniently saved in a **Tablet PC**.

**Who Should Attend**

This course is designed for electrical engineers, industrial & utility engineers, HSE personnel and other staff exposed to high voltages. Supervisors or managers concerned with the safety of electrical workers will find this course especially useful in providing an insight into electrical safety. Course participants are introduced to the hazards of electrical work and the philosophies of preventing accident and minimizing outage time due to improper safety or work practices. Also included as part of the curriculum are study materials participants may use at their own pace to continue their learning experience. This course addresses OSHA training requirements established in OSHA 29 CFR 1910.269 and other international standards.

**Training Methodology**

All our Courses are including **Hands-on Practical Sessions** using equipment, State-of-the-Art Simulators, Drawings, Case Studies, Videos and Exercises. The courses include the following training methodologies as a percentage of the total tuition hours:-

- 30% Lectures
- 20% Practical Workshops & Work Presentations
- 30% Hands-on Practical Exercises & Case Studies
- 20% Simulators (Hardware & Software) & Videos

In an unlikely event, the course instructor may modify the above training methodology before or during the course for technical reasons.

**Course Fee**

|       |   |
|-------|---|
| Doha  | <b>US\$ 6,000</b> per Delegate. This rate includes Participants Pack (Folder, Manual, Hand-outs, etc.), buffet lunch, coffee/tea on arrival, morning & afternoon of each day. |
| Dubai | <b>US\$ 5,500</b> per Delegate + <b>VAT</b> . This rate includes H-STK® (Haward Smart Training Kit), buffet lunch, coffee/tea on arrival, morning & afternoon of each day.    |



**Course Certificate(s)**

(1) Internationally recognized Competency Certificates and Plastic Wallet Cards will be issued to participants who completed a minimum of 80% of the total tuition hours and successfully passed the exam at the end of the course. Certificates are valid for 5 years.

**Recertification is FOC for a Lifetime.**

**Sample of Certificates**

The following are samples of the certificates that will be awarded to course participants:-

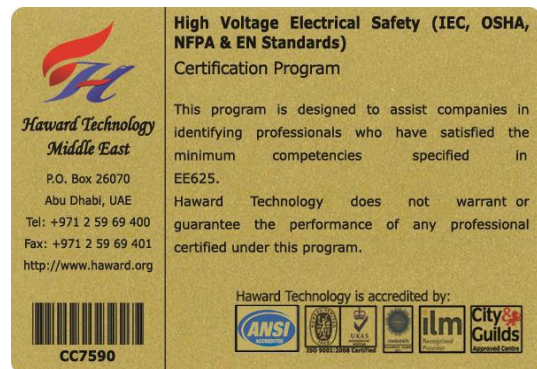
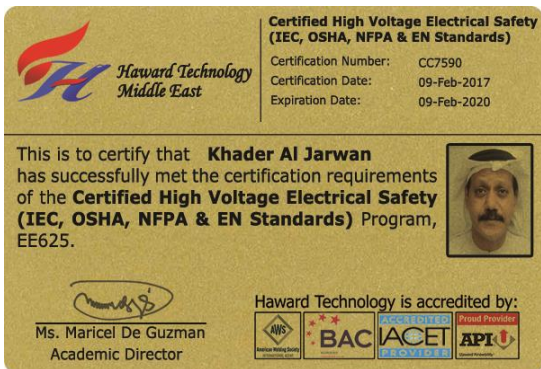



- (2) Official Transcript of Records will be provided to the successful delegates with the equivalent number of ANSI/IACET accredited Continuing Education Units (CEUs) earned during the course.

Page 1 of 1

**Haward Technology Middle East**  
Continuing Professional Development (HTME-CPD)

**CEU Official Transcript of Records**

**TOR Issuance Date:** 09-Feb-17  
**HTME No.** PAR213886  
**Participant Name:** Khader Al Jarwan

| Program Ref. | Program Title   | Program Date         | No. of Contact Hours | CEU's |
|--------------|---|----------------------|----------------------|-------|
| EE625        | Certified High Voltage Electrical Safety (IEC, OSHA, NFPA & EN Standards) | February 05-09, 2017 | 30                   | 3.0   |

Total No. of CEU's Earned as of TOR Issuance Date **3.0**

**TRUE COPY**

Maricel De Guzman  
Academic Director

Haward Technology has been approved as an Authorized Provider by the International Association for Continuing Education and Training (IACET), 1760 Old Meadow Road, Suite 500, McLean, VA 22102, USA. In obtaining this approval, Haward Technology has demonstrated that it complies with the ANSI/IACET 1-2013 Standard which is widely recognized as the standard of good practice internationally. As a result of their Authorized Provider membership status, Haward Technology is authorized to offer IACET CEUs for programs that qualify under the ANSI/IACET 1-2013 Standard.

Haward Technology's courses meet the professional certification and continuing education requirements for participants seeking Continuing Education Units (CEUs) in accordance with the rules & regulations of the International Association for Continuing Education & Training (IACET). IACET is an international authority that evaluates programs according to strict, research-based criteria and guidelines. The CEU is an internationally accepted uniform unit of measurement in qualified courses of continuing education.

Haward Technology is accredited by

P.O. Box 26070, Abu Dhabi, United Arab Emirates | Tel.: +971 2 3091 714 | Fax: +971 2 3091 716 | E-mail: info@haward.org | Website: www.haward.org



## Certificate Accreditations

Certificates are accredited by the following international accreditation organizations: -

- 
The International Accreditors for Continuing Education and Training (IACET USA)

Haward Technology is an Authorized Training Provider by the International Accreditors for Continuing Education and Training (IACET), 2201 Cooperative Way, Suite 600, Herndon, VA 20171, USA. In obtaining this authority, Haward Technology has demonstrated that it complies with the **ANSI/IACET 2018-1 Standard** which is widely recognized as the standard of good practice internationally. As a result of our Authorized Provider membership status, Haward Technology is authorized to offer IACET CEUs for its programs that qualify under the **ANSI/IACET 2018-1 Standard**.

Haward Technology's courses meet the professional certification and continuing education requirements for participants seeking **Continuing Education Units (CEUs)** in accordance with the rules & regulations of the International Accreditors for Continuing Education & Training (IACET). IACET is an international authority that evaluates programs according to strict, research-based criteria and guidelines. The CEU is an internationally accepted uniform unit of measurement in qualified courses of continuing education.

Haward Technology Middle East will award **3.0 CEUs** (Continuing Education Units) or **30 PDHs** (Professional Development Hours) for participants who completed the total tuition hours of this program. One CEU is equivalent to ten Professional Development Hours (PDHs) or ten contact hours of the participation in and completion of Haward Technology programs. A permanent record of a participant's involvement and awarding of CEU will be maintained by Haward Technology. Haward Technology will provide a copy of the participant's CEU and PDH Transcript of Records upon request.

- 
British Accreditation Council (BAC)

Haward Technology is accredited by the **British Accreditation Council** for **Independent Further and Higher Education** as an **International Centre**. BAC is the British accrediting body responsible for setting standards within independent further and higher education sector in the UK and overseas. As a BAC-accredited international centre, Haward Technology meets all of the international higher education criteria and standards set by BAC.

## Accommodation

Accommodation is not included in the course fees. However, any accommodation required can be arranged at the time of booking.



**Course Instructor(s)**

This course will be conducted by the following instructor(s). However, we have the right to change the course instructor(s) prior to the course date and inform participants accordingly:



**Mr. Ahmed Hayajneh** is a **Senior Electrical Engineer** with **20 years** of experience in **Oil, Gas, Petrochemical, Refinery & Power** industries. His expertise widely covers in the areas of **Electrical Safety**, High & Low Voltage **Electrical Safety, Power System Equipment, Transmission Network Maintenance, Electrical Forecasting Techniques, Inspection Reporting Techniques, Electrical Substation Design & Planning, Electrical Drawings & Schematics, Fault Detection Analysis, Distribution Networks & Load Forecasting, Power Generation, Electrical Power System, Electrical**

**Installations & Utilities, Electrical Distribution Systems & Control Circuits, Electrical Drawings, Relay Logic Circuits, Troubleshooting Transformers, System Grounding, Circuit Breakers, Protection Devices & Technology, Protection Relay, Transformers, Generators, Power Cable Standard and Testing, Power Transformers, Motors, Substations, Switchgears & Distribution, Power System Analysis, Electrical Equipment Control Systems, Transformer Maintenance & Testing, Electrical Substation & Design, Power Quality Studies & Load Criteria, LV/MV Electrical Safety (11 KV, 415 & 220 Voltage), Substation Earthing System, Electrical Equipment Maintenance, Cables & Wiring, Overhead Transmission Lines, Electrical Protection, Batteries, Chargers & UPS, Electrical Submersible Pumps (ESP), Power Supply Substations, Area Classification, Safety Management System, Permit to Work & Issuing Authority, Emergency Diesel Generator, Variable Frequency Drives (VFD), PLC & SCADA for Automation & Process Control, Automation Solutions & Techniques, Automating Process Equipment, DCS Automated Process Control Systems, Electrical Inspection & Testing, Electrical Control & Monitoring System, Electric Power System, Intensive Overhead Transmission Line (OHTL), Generator Maintenance & Troubleshooting, Transmission Line Networks, Distribution Engineering, HVDC Transmission & Control, Substation Maintenance Techniques and Overhead Power Line Construction & Patrolling.**

Mr. Ahmed gained his expertise and experience through several positions as a **Senior Electrical Project Engineer, Senior Electrical Engineer, Site Electrical Engineer** and **Senior Instructor/Trainer** for various companies such as United Electro-Mechanical International Company, AL OSAIS Contracting Co., ASTRACO, Saudi Service for Electro Mechanic Work Co. (S.S.E.M), Dubai Electricity & Water Authority (DEWA) and Saudi Electricity Company (SEC).

Mr. Ahmed has a **Bachelor's** degree in **Electrical Engineering**. Further, he is a **Certified Instructor/Trainer** and has delivered various trainings, seminars, conferences, workshops and courses globally.

**Course Program**

The following program is planned for this course. However, the course instructor(s) may modify this program before or during the course for technical reasons with no prior notice to participants. Nevertheless, the course objectives will always be met:

**Day 1**

|             |   |
|-------------|---|
| 0730 – 0800 | Registration & Coffee   |
| 0800 – 0815 | Welcome & Introduction  |
| 0815 – 0830 | <b>PRE-TEST</b>   |
| 0830 – 1045 | <b>Standards &amp; Regulations</b><br>IEC • OSHA • NFPA • IEEE • EN |
| 1045 – 1145 | <b>Standard Voltage</b><br>LV • MV • HV • EHV • UHV                 |
| 1145 – 1200 | Break   |
| 1200 – 1230 | <b>Basic Electricity</b><br>Direct Current                          |



|             |  |
|-------------|--|
| 1230 – 1300 | <b>Basic Electricity (cont'd)</b><br>Alternating Current |
| 1300 – 1315 | Break  |
| 1315 – 1420 | <b>Basic of HV Installations</b>                         |
| 1420 – 1430 | <b>Recap</b>   |
| 1430        | Lunch & End of Day One                                   |

**Day 2**

|             |   |
|-------------|---|
| 0730 – 0930 | <b>HV Equipment – Power Transformers</b><br>Types • Connections • Hazards & Testing • Troubleshooting • High Pot Testing • Step Regulators  |
| 0930 – 0945 | Break   |
| 0945 – 1045 | <b>HV Equipment – Switches, Isolators &amp; Fuses</b><br>Characteristics and Functions • Types & Ratings • Testing & Hazards  |
| 1045 – 1145 | <b>HV Equipment – Circuit Breakers</b><br>Characteristics and Functions • Types & Ratings • Testing & Hazards   |
| 1145 – 1230 | <b>HV Equipment – Instrument Transformers</b><br>Characteristics and Functions • Types & Ratings • Connections • Grounding • Testing  |
| 1230 – 1245 | Break   |
| 1245 – 1330 | <b>HV Equipment – Surge Arrestors</b><br>Characteristics and Functions • Types & Ratings • Testing & Hazards  |
| 1330 – 1420 | <b>HV Equipment – Capacitor Banks</b><br>Theory of Operation • Application & Hazards  |
| 1420 – 1430 | <b>Recap</b><br>Using this Course Overview, the Instructor(s) will Brief Participants about the Topics that were Discussed Today and Advise Them of the Topics to be Discussed Tomorrow |
| 1430        | Lunch & End of Day Two  |

**Day 3**

|             |   |
|-------------|---|
| 0730 – 0830 | <b>HV Equipment – Earth &amp; Shunt Reactors</b><br>Characteristics and Functions • Types   |
| 0830 – 0900 | <b>Gas Insulated Substations (GIS)</b><br>Characteristics • Applications  |
| 0900 – 0930 | <b>Metal-Enclosed &amp; Metal Clad Switchgears</b><br>Characteristics • Cubicles and Equipments   |
| 0930 – 0945 | Break   |
| 0945 – 1045 | <b>Motor Controllers</b>  |
| 1045 – 1145 | <b>Protection Relays</b>  |
| 1145 – 1230 | <b>Testing &amp; Commissioning</b>  |
| 1230 – 1300 | <b>Test Equipment</b><br>Ammeters, Ohmmeters, Voltmeters • Phase Angle Meters • Phasing Sticks/Devices • Oscilloscopes • Voltage Testers-Wiggy, etc. • Thumpers • Relay & Meter Test Equipment • Insulation Testers |
| 1300 – 1315 | Break   |
| 1315 – 1420 | <b>Electrical Switching</b><br>Switching Programmes • Loads • Transformers • Capacitors • Switches and Isolators  |
| 1420 – 1430 | <b>Recap</b><br>Using this Course Overview, the Instructor(s) will Brief Participants about the Topics that were Discussed Today and Advise Them of the Topics to be Discussed Tomorrow                             |
| 1430        | Lunch & End of Day Three  |







**Day 4**

|             |  |
|-------------|--|
| 0730 – 0830 | <b>Electrical Hazards</b><br>Electrical Shock and Effects • Electrical Arc • Safety Distances • Arc Blast • Accident Discussions   |
| 0830 – 0930 | <b>Special Hazards</b><br>Unique Designs • Special Operating Requirements  |
| 0930 – 0945 | Break  |
| 0945 – 1100 | <b>Hazardous Area Classification (HAC)</b><br>Defining Hazardous Areas (Zoning) • Why Area Classification? • Classifying Hazardous Materials • Ignition Sources – Identification and Control • Hazardous Area Classification (HAC) Standards • Identify & Reduce/Eliminate the Risk • Selection of Electrical Equipment in Hazardous Areas |
| 1100 – 1215 | <b>Safety Management</b><br>Quality Management System • Work Health and Safety System • Forms and Records • Audits • Policies • Costs  |
| 1215 – 1230 | Break  |
| 1230– 1420  | <b>De-Energized Work</b><br>Policies and Procedures • Voltage Detection Equipment • Lock and Tag Out • Permit to Work (PTW) • Grounds Grounds/Grounding • Personal Protective Grounds  |
| 1420 – 1430 | <b>Recap</b><br>Using this Course Overview, the Instructor(s) will Brief Participants about the Topics that were Discussed Today and Advise Them of the Topics to be Discussed Tomorrow  |
| 1430        | Lunch & End of Day Four  |

**Day 5**

|             |  |
|-------------|--|
| 0730 – 0830 | <b>Energized Work</b><br>Policies and Procedures • Recognition • Work Zones (Controlled Areas) • Work Clearances • Planning A Job • Proper Tools   |
| 0830 – 0900 | <b>Confined Space</b><br>Scope and Application • Training Requirements • Duties of Employers and Employees   |
| 0900 - 0930 | <b>Permit to Work (PTW) Procedure &amp; Implementation</b><br>Guidance Notes on Permit to Work (Site Specific if Requested) • Legal Responsibilities • Permit to Work (PTW) Key Players • Relationship between those Issuing Permits and those Working under PTW • When Should a Permit be Used • Who Issues Them • PTW Documentation • PTW Implementation |
| 0930 – 0945 | Break  |
| 0945 – 1045 | <b>Personnel Protection</b><br>Personal Protective Equipment (PPE) • Rubber Gloves/Blanket • Flash Suits • Eye Protection • Hard Hats • Explosion Protection   |
| 1045 – 1145 | <b>Emergency Planning</b><br>Communications • Electrical Fires and Fire Fighting • Phone Numbers • Panic Button • Tools/Equipment  |
| 1145 – 1200 | Break  |
| 1200 – 1300 | <b>Portable Cables</b><br>Application • Hazards  |
| 1300 – 1315 | <b>Course Conclusion</b><br>Using this Course Overview, the Instructor(s) will Brief Participants about the Course Topics that were Covered During the Course  |
| 1315 – 1415 | <b>COMPETENCY EXAM</b>   |
| 1415 – 1430 | Presentation of Course Certificates  |
| 1430        | Lunch & End of Course  |



### Simulators (Hands-on Practical Sessions)

Practical sessions will be organized during the course for delegates to practice the theory learnt. Delegates will be provided with an opportunity to carryout various exercises using our state-of-the-art simulators “Haward Troubleshooting”, “Power World”, “GE Multilin Relay 469” and “GE Multilin Relay 750”.

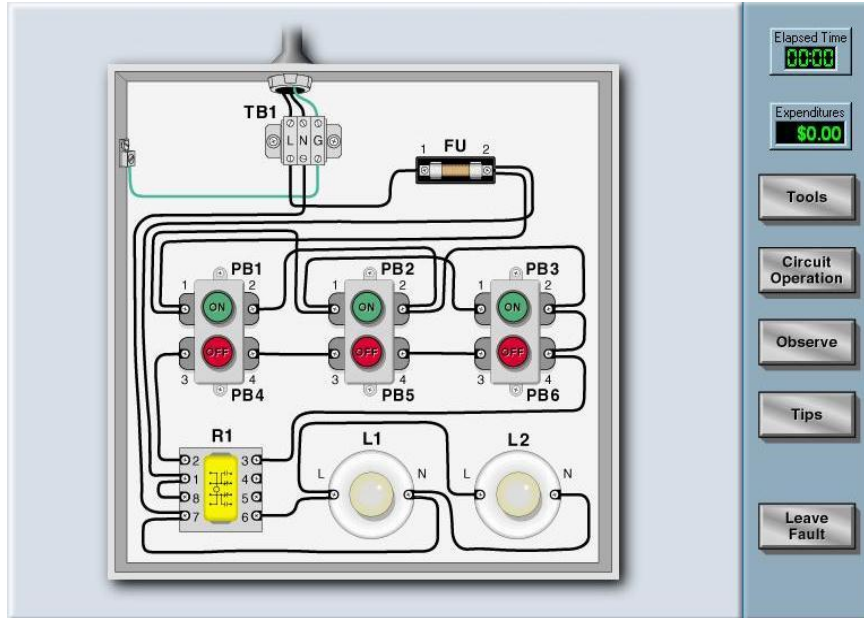

### Basic Techniques

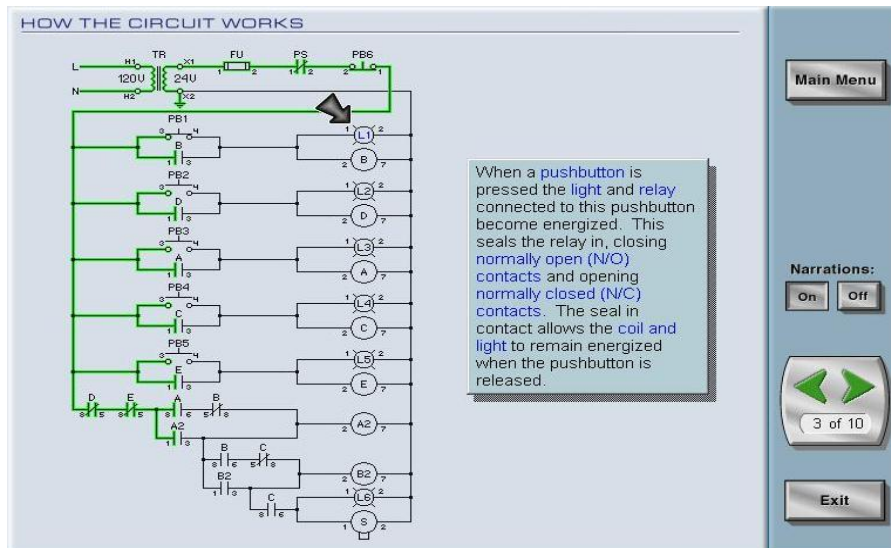

### Basic Control Circuits



**Motor Control Techniques**

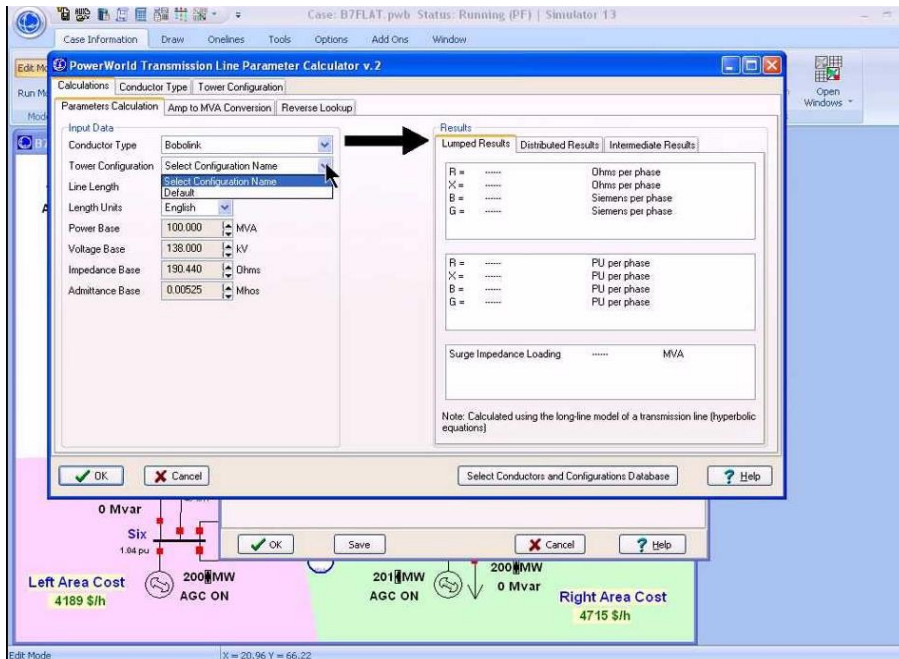

**Power World Simulator**







**GE Multilin Relay 469 Simulator**



**GE Multilin Relay 750 Simulator**

**Course Coordinator**

Jaryl Castillo, Tel: +974 4423 1327, Email: [jaryl@haward.org](mailto:jaryl@haward.org)